

Drawing Number: P8-007-□□□□□

1. Housing Material: Polycarbonate, UL Flammability Rating:

①=UL 94V-0, RoHS Compliant.

②=UL 94V-2, RoHS Compliant.

2. Contacts Type: ①=Straight pin fits Stranded wire only.

②=Two prong angled pin fits Solid/Stranded Wires.

③=Three prong pin fits Solid/Stranded Wires.

3. Gold Plating: ①= Fu" (Flash), ②=2-3u" ($0.0508 \mu\text{m} \leq A \leq 0.0762 \mu\text{m}$),

③= 3u" ($\geq 0.0762 \mu\text{m}$), ④= 6u" ($\geq 0.1524 \mu\text{m}$),

⑤=15u" ($\geq 0.381 \mu\text{m}$), ⑥=30u" ($\geq 0.762 \mu\text{m}$),

⑦=50u" ($\geq 1.27 \mu\text{m}$).

4. Packaging Quantity: ①=1000pcs, ②=500pcs, ③=250pcs, ④=200pcs

⑤= 100pcs, ⑥= 50pcs, ⑦= 25pcs, ⑧= 10pcs

⑨= Other

5. Housing Color: Transparent, other colors are available.

(Red=RD, Orange=OR, Yellow=YL, Green=GN, Blue=BL, Purple=PU, Black=BK)

6. Shielded Material: Brass with nickel plated, or Non-Shielded.

7. Operating Temperature: -10°C to 60°C.

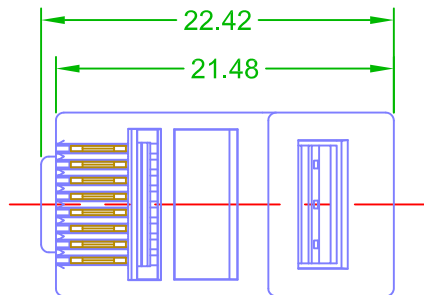
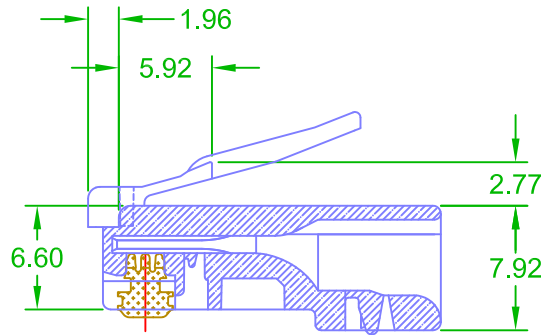
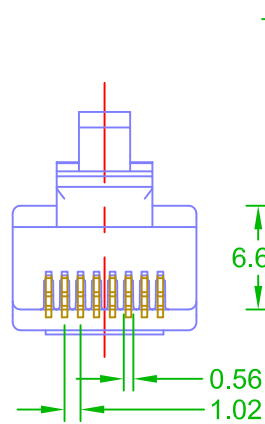
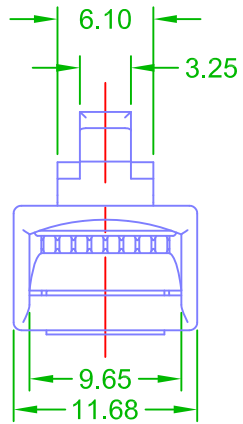
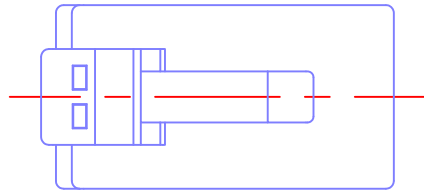
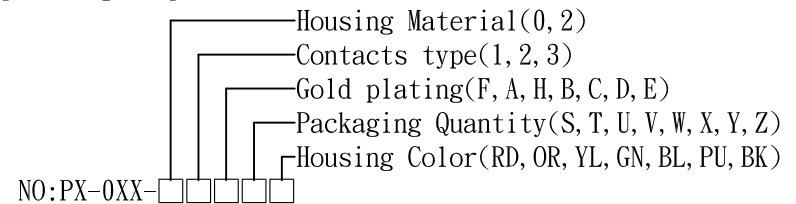

□ Straight pin



□ Two prongs pin



□ Three prongs pin

NOTE TOL: ±0.1

B	2017.11.27. Rescheduling coding	3RD	⊕ ⊖	Drawing	Chidy	Date	2004/11/11	UL Code	8P8C	
A	An initial version	Unit	m/m	Checked	Chris	Date	2004/11/11	Description		
Rev	Description	Scale	1:1	Approved	Jason	Date	2004/11/11	AC-8P8C-R-100		